

SG-425

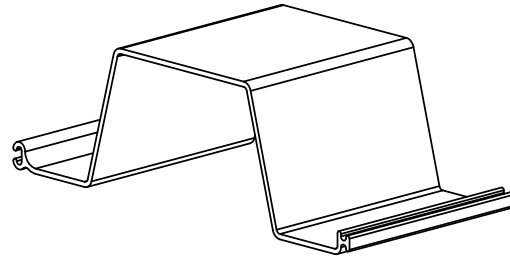

Allowable Moment (M)	3,813 ft-lb/ft	16.96 kN-m/m
Section Modulus (Z)	14.3 in ³ /ft	769 cm ³ /m
Moment of Inertia (I)	57 in ⁴ /ft	7,784 cm ⁴ /m
Impact Strength	13,750 in-lbs/in ²	2,406 N-mm/mm ²
Thickness (t)	0.285 in	7.2 mm
Section Depth	8.0 in	203 mm
Section Width	24 in	610 mm
Material	Weatherable Rigid Vinyl	
Standard Colors	Grey, Clay	
Technology	Box Profile, I-Beam Lock, XCR™	
Standard Packaging	20 sheets/bundle	

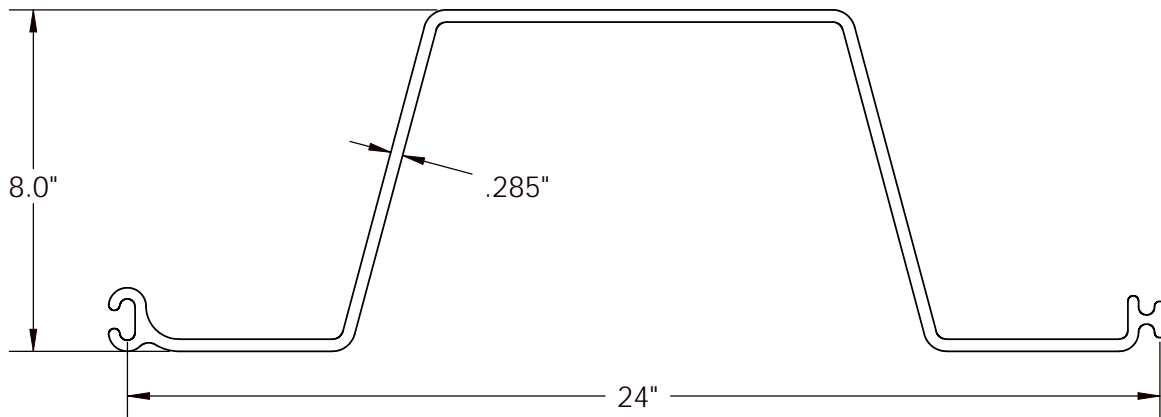

Physical properties are defined by ASTM testing standards, The Aluminum Association Design Manual, The Naval Facilities Design Manual DM 7.2, The US Army Corps of Engineers General Design Guide: PVC Sheet Pile and/or standard engineering practice. The values shown are nominal and may vary. The information found in this document is believed to be true and accurate. No warranties of any kind are made as to the suitability of any CMI product for particular applications or the results obtained there from. Crane Materials International is a Crane Building Products® company. ShoreGuard®, The ShoreGuard Seawall System™, C-Loc®, TimberGuard®, GeoGuard®, Dura Dock®, Shore-All®, GatorGates®, GatorDock Elite™, ArmorWare™, ArmorRod™, Box Profile™, UltraComposite™, Elite Wall™, Elite Panel™, Elite Fascia Panel™, Flat Panel™, XCR™, XCR Technology™, XCR Vinyl™, GatorBridge™, Gator Aluminum™, Gator Sheet Piling™, GatorDock™, I-Beam Lock™, Textured Slate™, Crane Materials International™ logo, CMI Sheet Piling Solutions™, Aqua Terra System™, Endurance™, Endurance CSPTM, Polaris™, Eclipse™, GridSpine™, 21 Poly™, PileClaw™, SheerScape™, SheerScape Retaining Wall Systems™, Sheer Panel™ and CMI Waterfront Solutions™ are trademarks, service marks or trade names of Crane Materials International. United States and International Patent numbers 4,674,921; 4,690,588; 5,292,208; 5,145,287; 6,000,883; 6,033,155; 6,053,666; D420,154; 6,575,667; 7,059,807; 7,056,066; 7,025,539; 7,393,482; 5,503,503; 5,803,672; 6,231,271; 1,245,061CA and other patents pending. © 2011 Crane Materials International. All Rights Reserved.